

# SPECIFICATION



REFOND P/N

---

Mass Product

# Contents

1. Description	
1.1 General Description	3
1.2 Features	3
1.3 Application	3
1.4 Package Dimension	4
1.5 Product Parameters	5
1.6 Typical optical characteristics curves	7
2. Packaging	
2.1 Packaging Specification	10
2.1.1 Carrier Tape Dimension	10
2.1.2 Reel Dimension	10
2.1.3 Label Form Specification	11
2.2 Moisture Resistant Packing	11
2.3 Cardboard Box	12
2.4 Reliability Test Items And Conditions	12
2.5 Criteria For Judging Damage	13
3. SMT Reflow Soldering Instructions SMT 回流焊说明	
3.1 SMT Reflow Soldering Instructions SMT	14
3.1.1 Soldering Iron	15
3.1.2 Repairing	15
3.1.3 Cautions	15
4. Handling Precautions	
4.1 Handling Precautions	16

## 1. Description

### 1.1 General Description

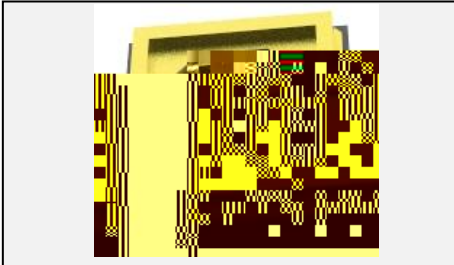

This production has a high reliability, good heat dissipation, are widely used in the disinfection, uv sterilization, Air purification, etc.

### 1.2 Features

Size(mm):3.5\*3.5\*1.4.

Viewing angle:120° .

Suitable for all SMT assembly and solder process.

Available on tape and reel.

Moisture sensitivity level: Level 3.

RoHS compliant.

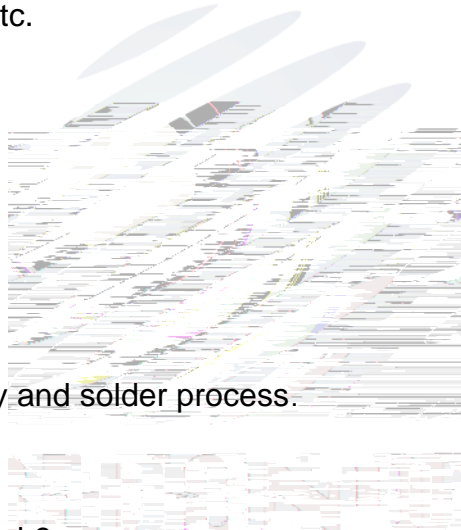

### 1.3 Application

Ultraviolet disinfection.

UV sterilization.

Air purification.

General use.

### 1.4 Package Dimension

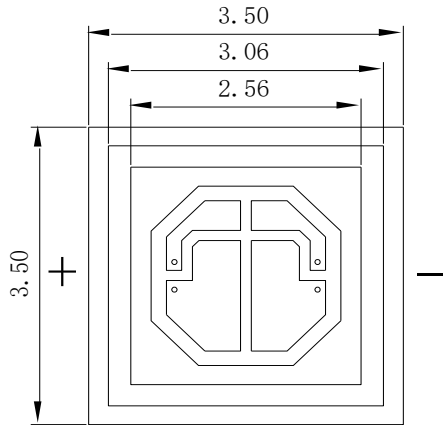

Fig.1-1 Top view

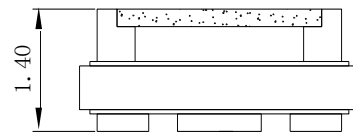

Fig.1-2 Side view

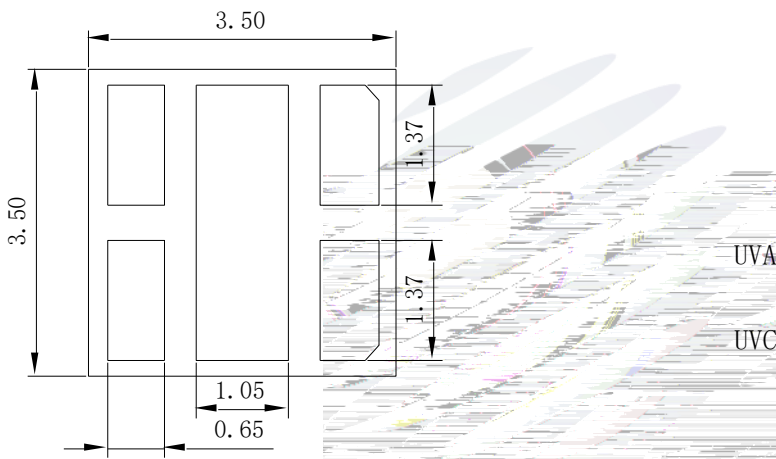

Fig.1-3 Bottom view

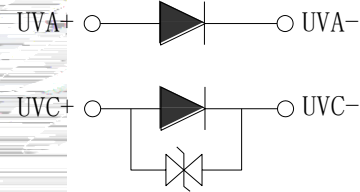

Fig.1-4 Polarity

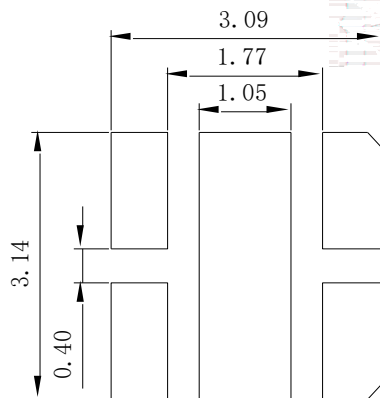

Fig.1-5 Soldering patterns

#### Notes

All dimensions units are millimeters.

All dimensions tolerances are  $\pm 0.2\text{mm}$  unless otherwise noted.

## 1.5 Product Parameters

Table 1-1 Electrical / Optical Characteristics at Ts=25°C

Item	Colour	Symbol	Test Condition	Code	Value			Unit
					Min.	Typ	Max.	
Forward Voltage	UVC	$V_F$	$I_F=20\text{mA}$	F02	4.5	---	5.5	V
				F03	5.5	6.2	6.5	
				F04	6.5	---	7.5	
	UVA	$V_F$	$I_F=20\text{mA}$	B11	3.0	---	3.2	
				B12	3.2	3.3	3.4	
				B13	3.4	---	3.6	
Reverse Current	UVC/A	$I_R$	$V_R=10\text{V}$	---				



Table 1-2 Absolute Maximum Ratings at Ts=25°C

Parameter	Symbol	Rating	Units
Maximum Power Dissipation	$P_D$	0.45	W
Peak Forward Current	$I_{FP}$	40	mA
Reverse Voltage	$V_R$	10	V
Electrostatic Discharge (HBM)	$E_{SD}$	1000	V
Operating Temperature	$T_{OPR}$	-40 ~ +45	
Storage Temperature	$T_{OPR}$	-20 ~ +65	
Junction Temperature	$T_J$	60	

## Notes

- 1/10 Duty cycle, 0.1ms pulse width.
- The above forward voltage measurement allowance tolerance is  $\pm 0.1V$ .
- The above wavelength measurement allowance tolerance is  $\pm 2nm$ .
- The above radiation flux measurement allowance tolerance  $\pm 10\%$ .
- Care is to be taken that power dissipation does not exceed the absolute maximum rating of the product.
- All measurements were made under the standardized environment of Refond.
- When the LEDs are in operation the maximum current should be decided after measuring the package temperature, junction temperature should not exceed the maximum rate
- ESD yield is over 90% at 1000V ESD (HBM). ESD protection during products handing is needed.

## 1.6 Typical optical characteristics curves

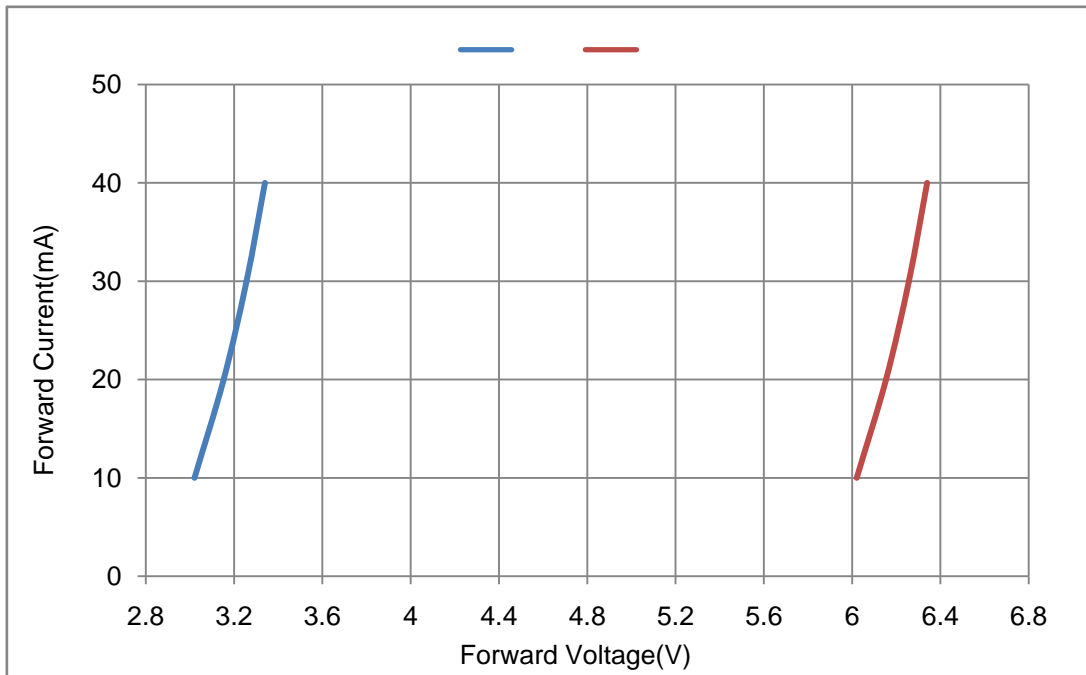

Fig.1- Forward Voltage Vs. Forward Current

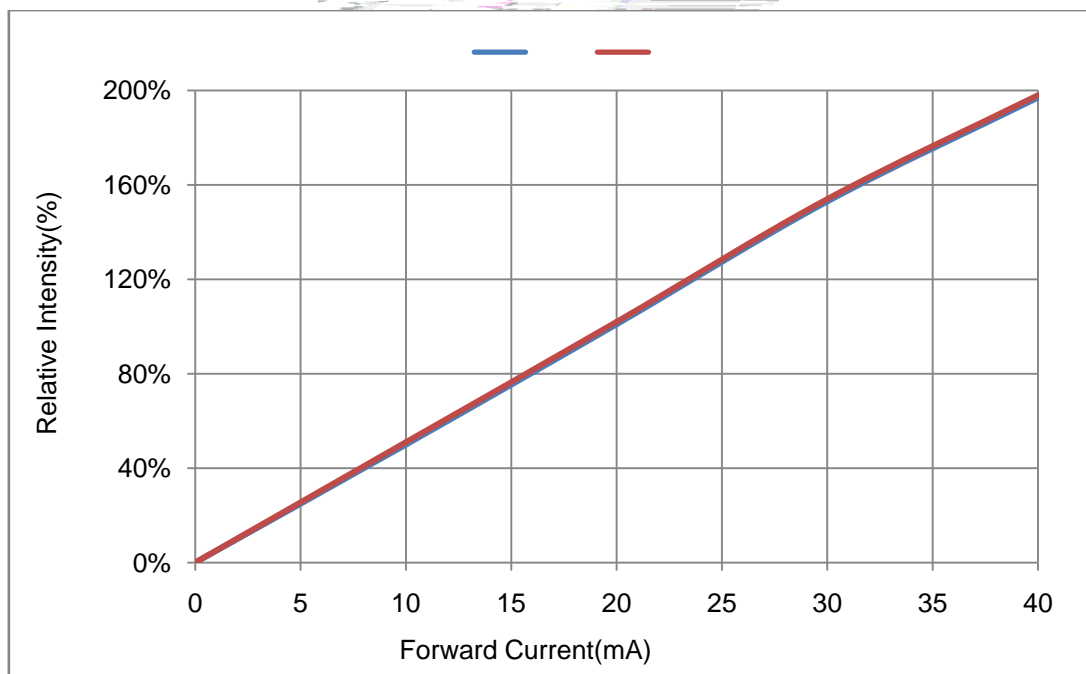

Fig.2- Forward Current Vs. Relative Power

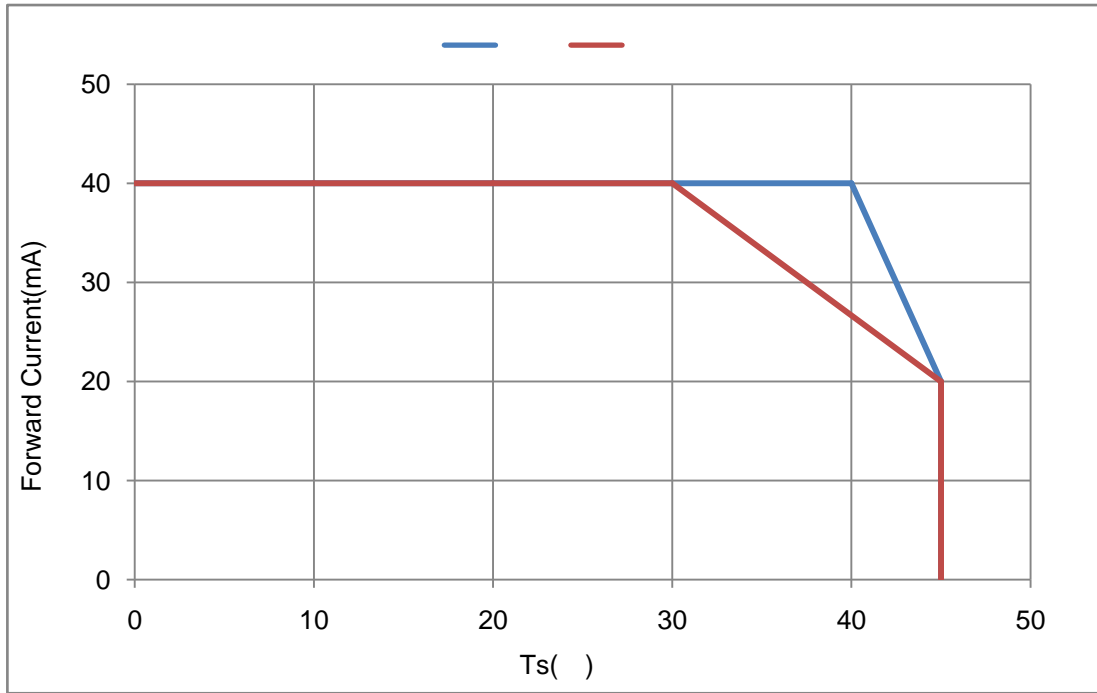

Fig.3-Ts Temperature VS. Forward Current

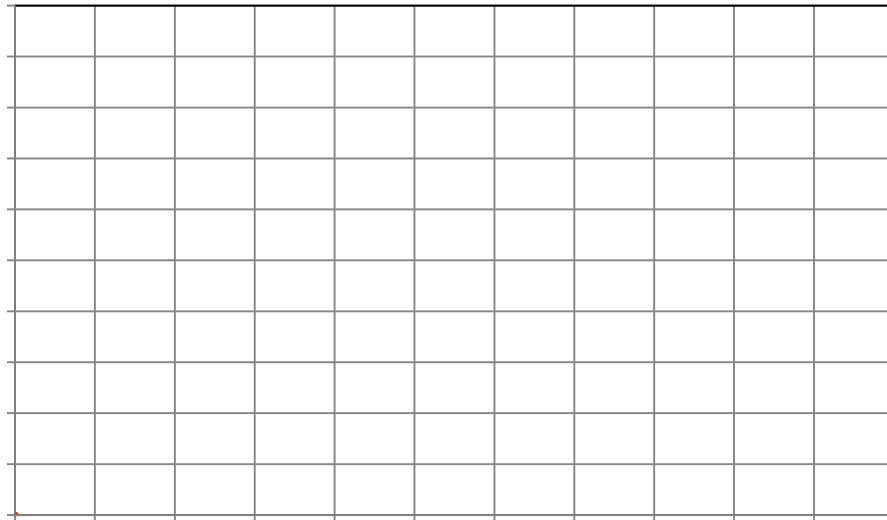
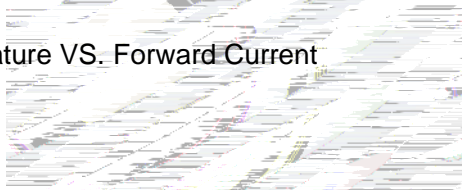

Fig.4-Spectrum Distribution



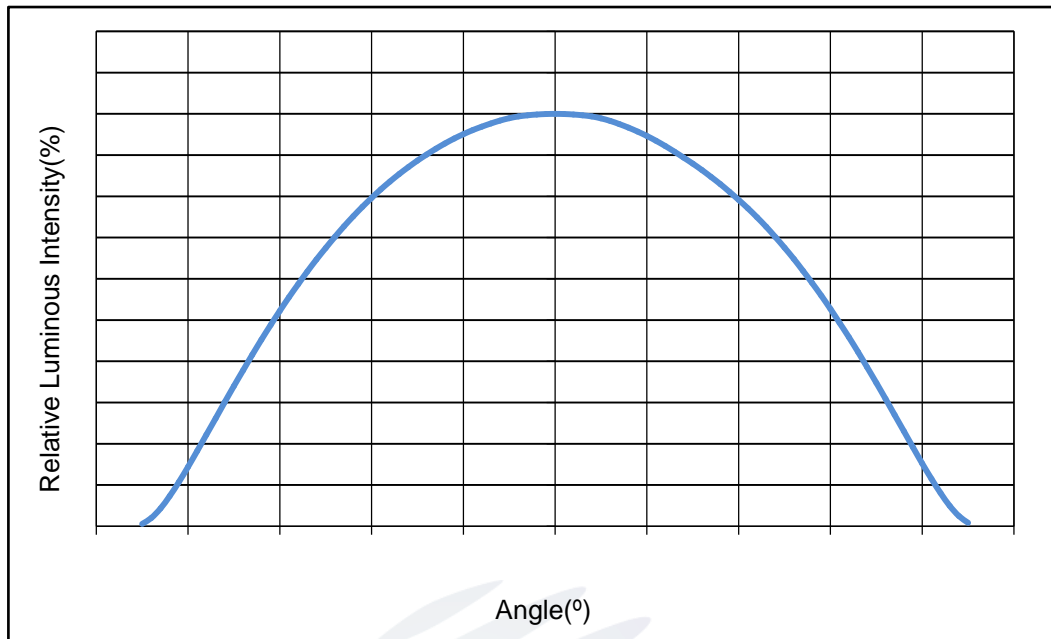
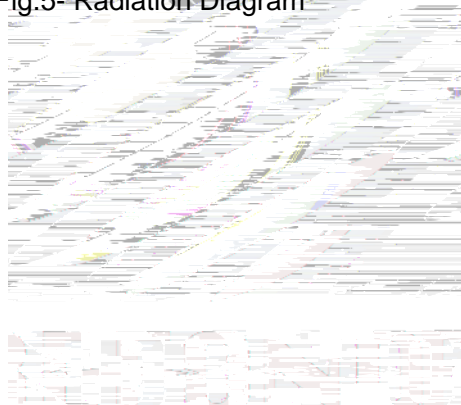

Fig.5- Radiation Diagram



## 2. Packaging

### 2.1 Packaging Specification

Package:1000pcs/reel.

#### 2.1.1 Carrier Tape Dimension

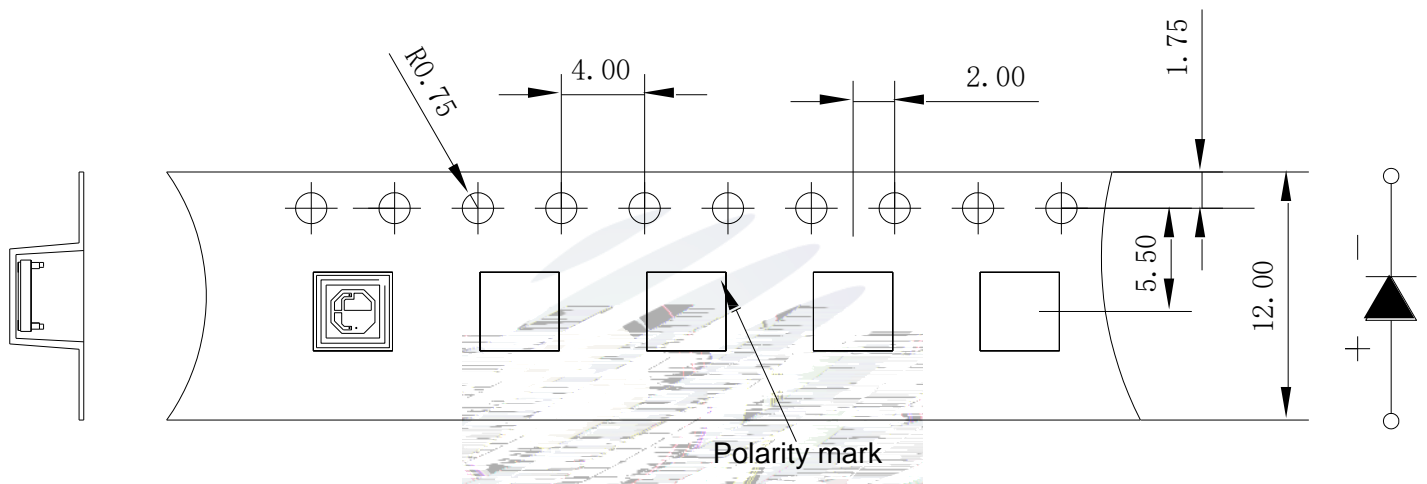
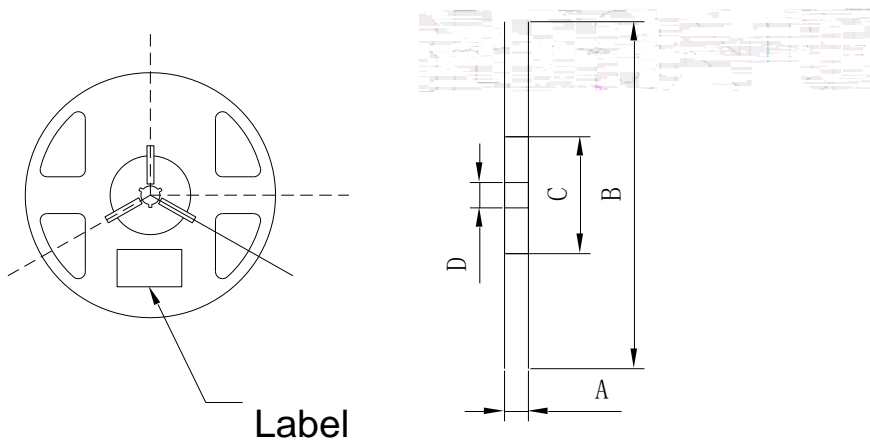

Fig.2-1 Carrier Tape Dimension

#### 2.1.2 Reel Dimension



Reel Dimension

A	12 0.1mm
B	178 1mm
C	60 1mm
D	13.0 0.5mm

Fig.2-2 Reel Dimension

#### Notes

The tolerances unless mentioned  $\pm 0.1\text{mm}$ . Unit : mm

### 2.1.3 Label Form Specification

#### Label Form Specification

PART NO.      Part Number

Fig. 2-3 Label Form Specification



### 2.2 Moisture Resistant Packing

Fig.2-4 Moisture Resistant Packing Process

### 2.3 Cardboard Box

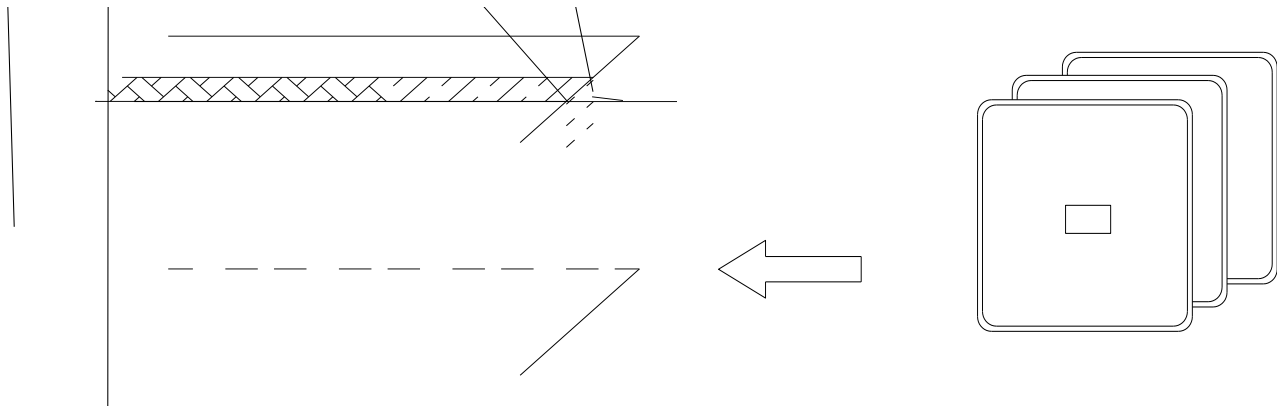

Fig.2-5 Cardboard Box

### 2.4 Reliability Test Items And Conditions

Table 2-3 Reliability Test Items And Conditions

Test Items	Ref.Standard	Test Condition	Time	Quantity	Ac/Re
Reflow	JESD22-B106	Temp:260 max T=10 sec	3times.	10Pcs.	0/1
Thermal Shock	JESD22-A106	-40 15min 100 15min	100 Cycles	10Pcs.	0/1
Life Test	JESD22-A108	T <sub>a</sub> =25 I <sub>F</sub> =20mA	1000Hrs.	10Pcs.	0/1

## 2.5 Criteria For Judging Damage

Table 2-4 Criteria For Judging Damage

Test Items	Symbol	Test Condition	Criteria For Judgement	
			Min.	Max.
Forward Voltage	$V_F$	$I_F=20\text{mA}$	-	U.S.L*)x1.1
Reverse Current	$I_R$	$V_R = 10\text{V}$	-	U.S.L*)x2.0
Total radiant flux	$e$	$I_F=20\text{mA}$	L.S.L*)x0.7	-

### Notes

- 1.U.S.L: Upper standard level      L.S.L: Lower standard level
2. The above reliability tests is based on the verification of a single/strip LED of Refond's existing experimental platform, the reliability experiment was taken under good heat dissipation conditions. when customers applies the LED to the series and parallel circuit, should take consideration of all the factors such as the current, voltage distribution, heat dissipation and others.
- 3.The technical information shown in the data sheets is limited to the typical characteristics and circuit examples of the referenced products. It does not constitute the warranting of industrial property nor the granting of any license.

### 3. SMT Reflow Soldering Instructions SMT 回流焊说明

#### 3.1 SMT Reflow Soldering Instructions SMT

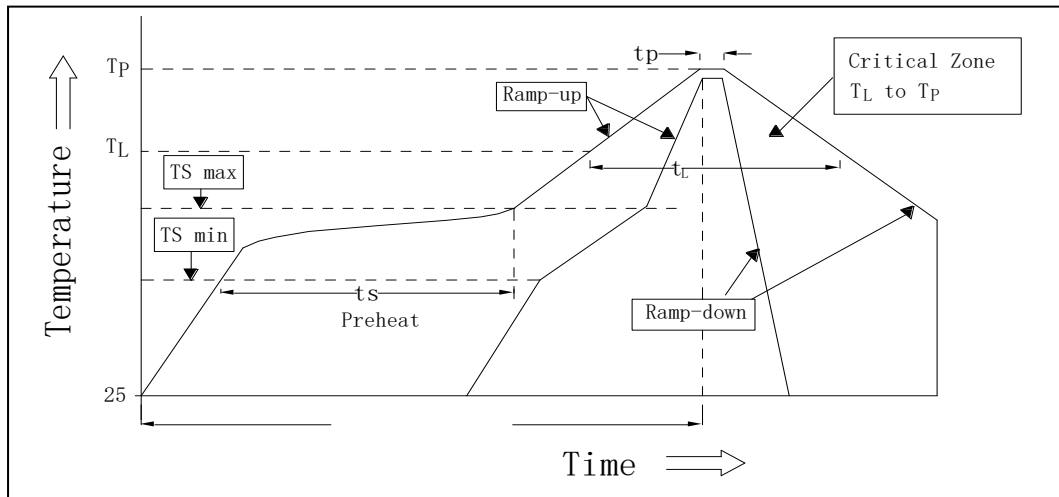

Fig.3-1 SMT Reflow Soldering Instructions

Table 3-1 SMT Reflow Soldering Instructions

Average temperature rise speed	Tsmax	T <sub>P</sub>	Max 3 °C/ s	3 °C/
Preheating: minimum temperature	(T <sub>smin</sub> )		150 °C	
Preheating: Max temperature	(T <sub>smax</sub> )		200 °C	
Preheating: Time	T <sub>smin</sub>	T <sub>smax</sub>	60s-120s	60 - 120
Time limited to maintain high temperature: the temperature (T <sub>L</sub> )			217 °C	
Time limited to maintain high temperature: The Time (t <sub>L</sub> )			Max 60s	60
Peak /Classification of temperature:	/	(T <sub>P</sub> )	260 °C	
Time limit classification of peak temperature time t <sub>p</sub>			Max 10s	10
Hold time within 5 °C with the actual peak temperature (T <sub>P</sub> ) 5 °C			Max 30s	30
Cooling speed			Max 6 °C/ s	6 °C/
Needed time from 25 °C to T <sub>P</sub> 25 °C			Max 8 minutes	8

Notes

(1)Reflow soldering should not be done more than twice. If more than 24 hours between the two solderings , LED will be damaged.

(2)When soldering , do not put stress on the LEDs during heating.

3.1.1 Soldering Iron

(1) When do soldering by hand, keep the temperature of iron below less 300 less than 3 seconds.

(2) Soldering by hand should be done only one time.

3.1.2 Repairing

Repairing should not be done after the LEDs have been soldered. When repairing is unavoidable,a double-head soldering iron should be used (as below figure). It should be confirmed in advance whether the characteristics of LEDs will or not be damaged by repairing.

LED

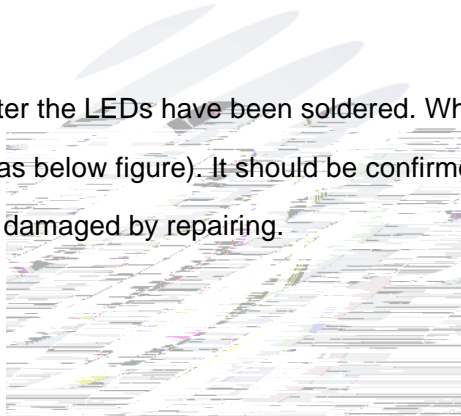

3.1.3 Cautions

(1) The encapsulated material of the LEDs is silicone. Therefore the LEDs have a soft surface on the top of package. The pressure to the top surface will be impacted on the reliability of the LEDs. Precautions should be taken to avoid the strong pressure on the encapsulated part. So when use the picking up nozzle, the pressure on the silicone resin should be proper. LED

(2) Components should not be mounted on warped (non coplanar) portion of PCB. After soldering, do not warp the circuit board.LED

(3) Do not apply mechanical force or excess vibration during the cooling process to normal temperature after soldering. Do not rapidly cool device after soldering.

## 4. Handling Precautions

### 4.1 Handling Precautions



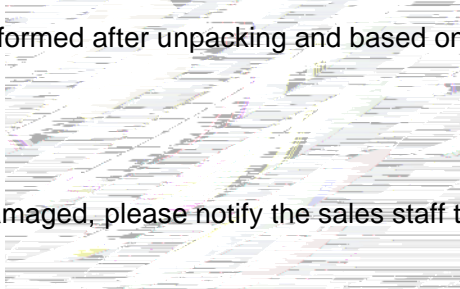



Table 4-1 Storage

Conditions		Temperature	Humidity	Time
Storage	Before Opening Aluminum Bag	30	75%	Within 1 Year From Date
	After Opening Aluminum Bag	30	60%	24hours 24
Baking		60 5	-	24hours 24

(8) If the moisture absorbent material silica gel has faded away or the LEDs have exceeded the storage time, baking treatment should be performed after unpacking and based on the following condition 65 5 for above 24 hours.



If the package is flatulence or damaged, please notify the sales staff to assist.

(9) Similar to most Solid state devices; LEDs are sensitive to Electro-Static Discharge (ESD) and Electrical Over Stress (EOS).

(10) When using this product, you need to take good care to prevent it from causing harm to eyes and human body.

(11) Other points for attention, please refer to our relevant information.

Date	Revisor	Version	Verifier
------	---------	---------	----------





Declare

This specification is written both in English and in Chinese and the latter is formal.