

# SPECIFICATION

# 产品规格书

REFOND P/N 产品型号

RF-W1SA28IS-A42

R&D 研发

Mass Product 量产供货

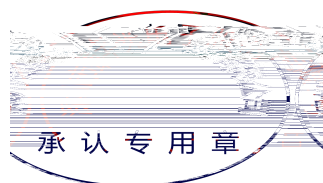

## Contents 目錄

1. Description 产品介绍 .....	4
1.1 General Description 产品描述 .....	4
1.2 Features 产品特征 .....	4
1.3 Application 产品应用 .....	4
1.4 Package Dimension 封装尺寸 .....	5
1.5 Product Parameters 产品参数 .....	6
1.6 Typical optical characteristics curves 典型光学特性曲线 .....	7
2. Packaging 产品包装 .....	11
2.1 Packaging Specification 包装规格 .....	11
2.1.1 Carrier Tape Dimension 载带尺寸 .....	11
2.1.2 Reel Dimension 卷盘尺寸 .....	11
2.1.3 Label Form Specification 标签规格 .....	12
2.2 Moisture Resistant Packing 防潮包装 .....	12
2.3 Cardboard Box 包装纸箱 .....	13
2.4 Reliability Test Items And Conditions 信赖性测试项目及条件 .....	13
2.5 Criteria For Judging Damage 失效判定标准 .....	14
3. SMT Reflow Soldering Instructions SMT 回流焊说明 .....	15
3.1 SMT Reflow Soldering Instructions SMT 回流焊说明 .....	15
3.1.1 Soldering Iron 烙铁焊接 .....	17
3.1.2 Repairing 维修 .....	17
3.1.3 Cleaning 清洗 .....	17
4. Handling Precautions 产品使用注意事项 .....	18
4.1 Handling Precautions 产品使用注意事项 .....	18
4.1.1 Storage 贮存 .....	18
4.1.2 Static Electricity 静电 .....	18
4.1.3 Reverse voltage protection 反压保护 .....	19
4.1.4 The safe temperature for LEDs working 温度保护 .....	19

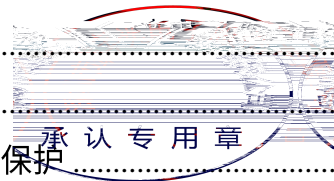

4.1.5 Others 其它事项 .....20

4.1.6 Declare 申明.....20

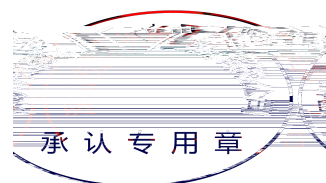

## 1. Description 产品介绍

### 1.1 产品描述

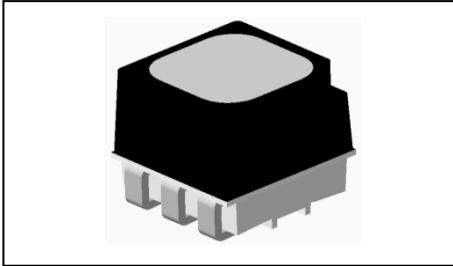

The product is a full-color LED device, High contrast(Surface brush design ). The product size: 2.8mmx2.7mmx2.45mm.

该产品为全彩 LED 器件，高对比度(表面刷墨设计)，产品尺寸: 2.8mmx2.7mmx2.45mm。

### 1.2 Features 产品特征

- ▶ Surface not reflective. 表面不反光
- ▶ High luminous Intensity, Low power dissipation, Good reliability and Long life.  
光强高、功耗低、可靠性好、寿命长
- ▶ Water-resistant(IPX6): 防水等级(IPX6)
- ▶ Moisture sensitivity level: 5a 潮湿敏感等级:5a
- ▶ RoHS compliant. 满足RoHS要求
- ▶ Matte surface. 哑光表面
- ▶ Pb-free reflow soldering application. 无铅回流焊

### 1.3 Application 产品应用

- ▶ Outdoor full-color video screen. 户外全彩显示屏
- ▶ The automobile dashboard. 汽车仪表盘
- ▶ Indoor and outdoor decorative lighting. 室内外装饰照明
- ▶ Amusement. 娱乐产品
- ▶ General use. 其他应用



### 1.4 Package Dimension 封装尺寸

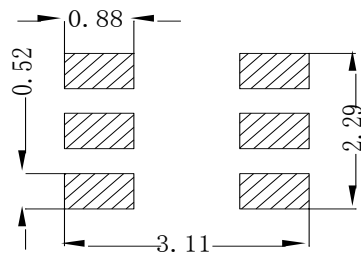
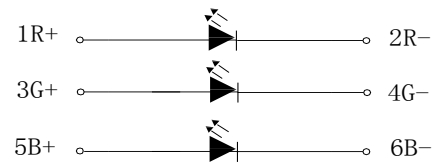
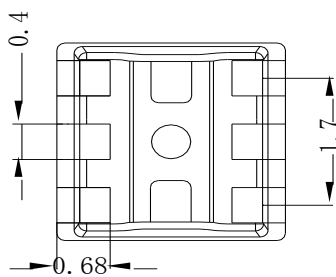
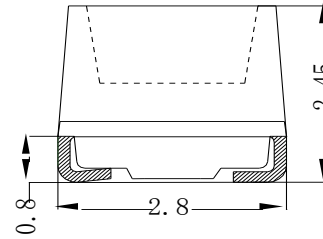
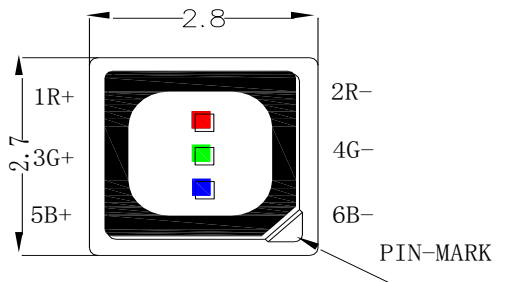

#### Notes 备注:

1. All dimensions units are millimeters. 所有尺寸标注单位为毫米
2. All dimensions tolerances are  $\pm 0.1$ mm unless otherwise noted. 除特别标注外, 所有尺寸公差为  $\pm 0.1$  毫米



## 1.5 Product Parameters 产品参数

Table 1-1 Electrical / Optical Characteristics at Ts=25°C 电性与光学特性

Item 项目	Symbol 符号	Test Condition 测试条件	Value			Unit 单位
			R	G	B	
Reverse Current (漏电流)	$I_R$	$V_R=5V$	6	6	6	$\mu A$
Forward Voltage (正向电压)	$V_{F(min)}$	R $I_F = 20mA$ G $I_F = 20mA$ B $I_F = 20mA$	1.8	2.7	2.7	V
	$V_{F(max)}$		2.4	3.4	3.4	V
Dominant Wavelength 主波长	$\lambda_D$		618~628	518~530	464~474	nm
Spectrum Radiation Bandwidth 半波宽	$\Delta \lambda$		24	38	30	nm
Luminous Intensity 光强	$I_{V(min)}$		808	1538	345	mcd
	$I_{V(avg)}$		1050	2000	450	mcd
Viewing Angle (发光角度)	2 $\theta$ 1/2		110			deg

Table 1-2 Absolute Maximum Ratings at Ts=25°C 绝对最大值

Parameter (参数)	Symbol (符号)	Rating (值)			Unit 单位
		R	G	B	
Forward Current (正向电流)	$I_F$	25	20	20	mA
Peak Forward Current (峰值电流)	$I_{FP}$	80	80	80	mA
Reverse Voltage (反向电压)	$V_R$	5	5	5	V
Operating Temperature (操作温度)	$T_{OPR}$	-30 ~ +85			
Storage Temperature (储存温度)	$T_{STQ}$	-40 ~ +100			
Power Dissipation (功耗)	$P_D$	60	68	68	mW
Electrostatic Discharge (HBM) (静电)	$E_{SD}$	1000V			

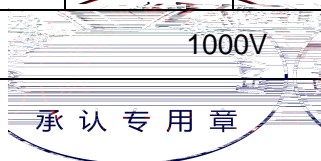

## Notes 备注:

1. 1/10 Duty cycle, 0.1ms pulse width. 脉宽0.1ms,占空比1/10.
2. The above forward voltage measurement allowance tolerance is  $\pm 0.05V$ . 以上所示电压测量误差  $\pm 0.05V$ 。
3. The above Tolerance of measurement of dominant wavelength  $\pm 1nm$ . 以上所示波长测量公差  $\pm 1nm$ 。

c7)6(l)4(4)T(Ch)5av)B(am)0)0)1(um)3(me)8)ure)3(est)4(0)4(D)4(r)0(a)9)4)3)29(ss)2)z)5)2)6)4(m)5)e)2)1)5)6-4(37en-US)-BDC9.364





Fig 1-9 Solder Temperature Vs Forward Current

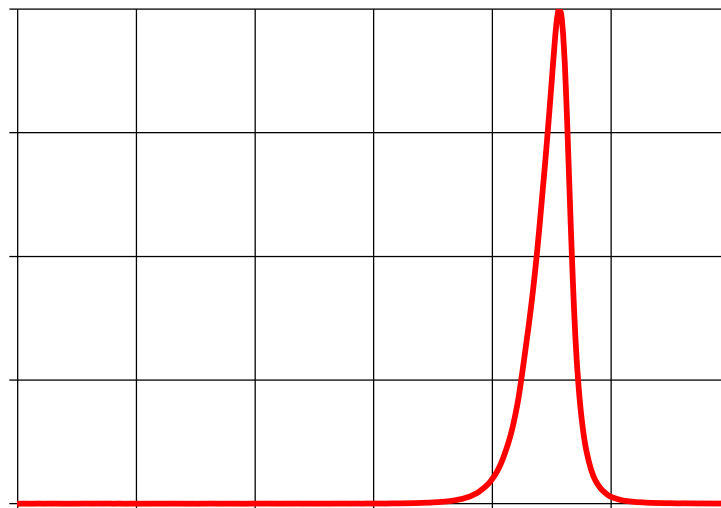
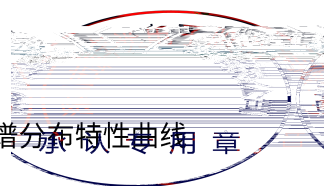

Fig 1-10 Spectrum Distribution



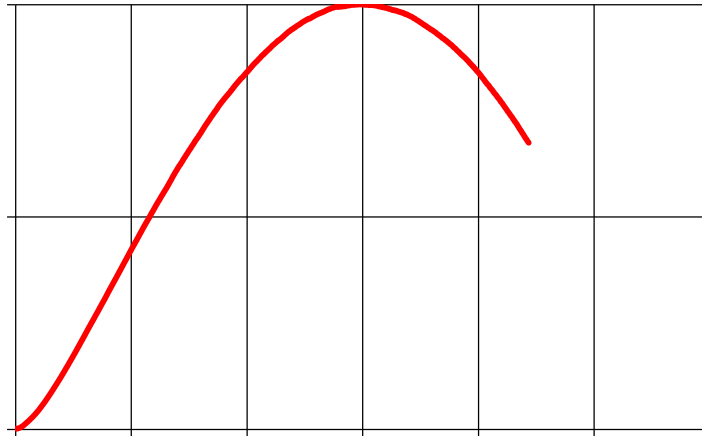
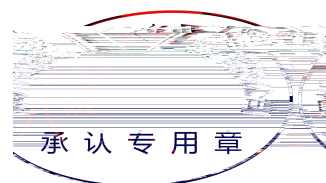

Fig 1-11 Directivity X-X radiation angle X轴方向辐射角度

Fig 1-12 Directivity Y-Y radiation angle Y轴方向辐射角度



## 2. Packaging 产品包装

### 2.1 Packaging Specification 包装规格

Package:3000pcs/reel.包装每卷 3000pcs。

#### 2.1.1 Carrier Tape Dimension 载带尺寸

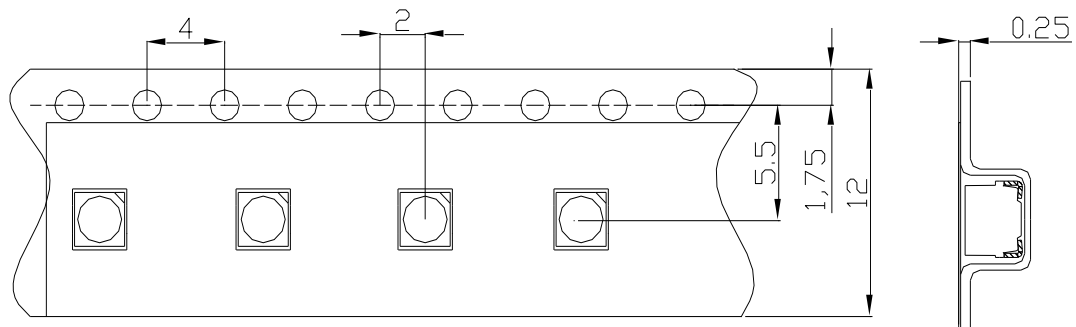

Fig.2-1 Carrier Tape Dimension 载带尺寸

#### 2.1.2 Reel Dimension 卷盘尺寸

Table 2-1 Title 表名

A	320.2±2mm
B	79.5±0.2mm
C	14.3±0.2mm
D	2.5±0.2mm
E	15.5±0.2mm
F	12.7±0.3mm
T	2.0±0.2mm

Fig.2-2 Title 图名

Notes 备注:

The tolerances unless mentioned  $\pm 0.1\text{mm}$ . Unit : mm 注：未注公差为 $\pm 0.1$ 毫米,尺寸单位：毫米。

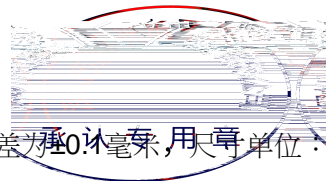

### 2.1.3 Label Form Specification 标签规格

Table 2-2 Title 表名

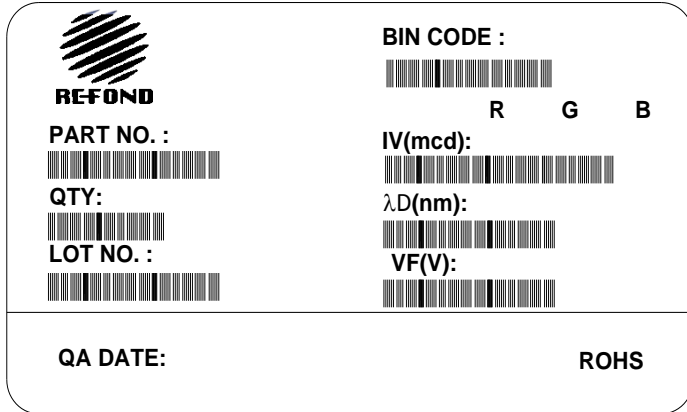

PART NO.	Part Number	品名
LOT NO.	Lot Number	批次号
BIN CODE	Bin Code	参数代码
IV	Llight intensity	光强
VF	Forward Voltage	正向电压
λD	Wavelength	波长代码
QTY	Packing Quantity	数量
DATE	Made Date	生产日期

Fig 2-3 Title 图名

### 2.2 Moisture Resistant Packing 防潮包装

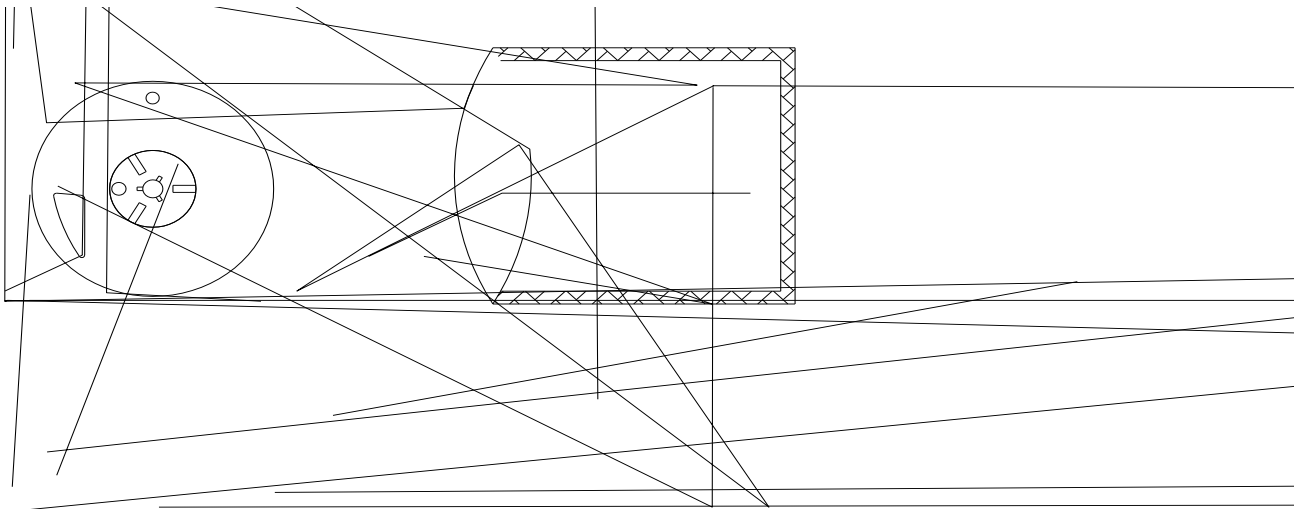

Fig.2-4 Title 图名

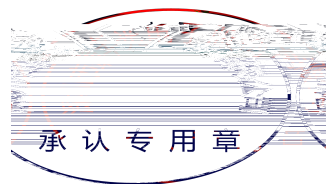







Table 3-1 Title 表名

Average temperature rise speed平均升温速度 (T <sub>max</sub> 至T <sub>P</sub> )	Max 4 °C/ s 最高4 °C/秒
Preheating: minimum temperature预热: 最低温度 (T <sub>min</sub> )	150 °C
Preheating: Max temperature预热: 最高温度 (T <sub>max</sub> )	200 °C
Preheating: Time预热: 时间 (T <sub>min</sub> 至T <sub>max</sub> )	60s-120s 60 - 120秒
Time limited to maintain high temperature: the temperature 限时维持高温: 温度 (T <sub>L</sub> )	217 °C
Time limited to maintain high temperature: The Time 维持高温: 时间 (T <sub>L</sub> )	Max 60s 最多60秒
Peak /Classification of temperature: 峰值 / 分类温度 (T <sub>P</sub> )	250 °C
Time limit classification of peak temperature time 限时峰值分类温度: 时间 (t <sub>p</sub> )	Max 10s 最多10秒
Hold time within 5 °C with the actual peak temperature (T <sub>P</sub> ) 与实际峰值温度 (T <sub>P</sub> ) 相差 5 °C 以内的保持时间	Max 30s 最多30秒
Cooling speed 降温速度	Max 6 °C/ s 最高6 °C/秒
Needed time from 25 °C to T <sub>p</sub> 25 °C 升至峰值温度所需时间	Max 8 minutes 最多8分钟

## Notes 备注:

- 1.Reflow soldering should not be done more than one times.回流焊接最多只能进行一次.
- 2.It is recommended that use the middle temperature solder paste.推荐使用中温锡膏生产加工
- 3.Stress on the LEDS should be avoided during heating in soldering process.在回流焊接过程中,不要对 LED 施加任何压力.
- 4.After soldering ,do not deal with the product before its temperature drop down to room temperature.在焊接完成后,待产品温度下降到室温后,再进行其它处理.





### 3.1.1 Soldering Iron 烙铁焊接

(1) When hand soldering, keep the temperature of iron below less 300°C less than 3 seconds

当手工焊接时，烙铁的温度必须小于300°C，时间不可超过3秒。

(2) The hand solder should be done only one time.手工焊接只可焊接一次。

### 3.1.2 Repairing 维修

Repair should not be done after the LEDs have been soldered. When repairing is unavoidable, a double-head soldering iron should be used (as below figure). It should be confirmed in advance whether the characteristics of LEDs will or will not be damaged by repairing.

## 4.Handling Precautions 产品使用注意事项

### 4.1 Handling Precautions 产品使用注意事项

#### 4.1.1 Storage 贮存

(1) Moisture proof and anti-electrostatic package with moisture absorbent material is used, Packaged products have one year to save time.

本产使用密封防潮抗静电袋包装,并附有干燥剂,未开封的产品保存时间一年.

(2) Before opening the package, the product should be kept at 30 or less and humidity less than 60%RH.

开封前,产品须存放在温度不高于30°C,湿度不高于60%RH的环境中.

(3) Seal anti-electrostatic bag humidity card should immediately check bag humidity indicator card in the open the bag after, Humidity is greater than or equal to 30%, Must be baked before use  
密封防静电袋内的湿度卡应在打开袋子后立即查看袋内的湿度指示卡来确定,湿度显示大于或等于30%时,使用前须进行烘烤.

(4) After opening the package, the product should be soldered within 24 hours. If not, please store at 30 or less and humidity less than 10%RH. It is recommended that the product be operated at the workshop condition of 30 or less and humidity less than 60%RH.

开封后,产品必须24小时内使用完(建议工作环境温度不高于30°C,湿度不高于60%),如未使用完,须存放在温度不高于30°C,湿度不高于10%的环境中.

(5) If the moisture absorbent material has fade away or the LEDs have exceeded the storage time, baking treatment should be performed based on the following condition : 65±5°C for 24 hours.

对于尚未焊接的LED,如果吸湿剂或包装失效,或者产品没有符合以上有效存储条件,烘烤可以起到一定的性能恢复效果, 烘烤条件:65±5 ,持续时间24H.

#### 4.1.2 Static Electricity 静电

(1) The following procedures may decrease the possibility of ESD damage.

以下操作可降低静电破坏的可能性

(2) Minimize friction between the product and surroundings to avoid static buildup.

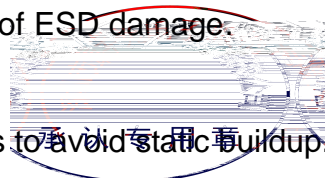

将产品和外界之间的摩擦减到最低以避免静电产生.

(3) All production machinery and test instruments must be electrically grounded.

所有的产品设备和测试仪器必须接地.

(4) Operators must wear anti-static bracelets.

操作人员必须配戴静电环.

(5) Wear anti-static suit when entering work areas with conductive machinery.

进入带电设备工作区域时必须穿戴防静电服.

(6) All workstations that handle IC and ESD-sensitive components must maintain an electrostatic potential of 150V or less.

所有操作 IC 和 ESD 敏感器件的工作台必须保持低于 150V 的静电保护.

#### 4.1.3 Reverse voltage protection 反压保护

In generally the reverse current of LED is very small, it can't effect using the component normally, but when it often suffered the reverse voltage which exceed the limits of the component than it will be damaged, the reverse current increases rapidly causing the string light display gray scale so when designing, please pay attention to control the reverse voltage we suggest the reverse voltage less than 10V.

通常 LED 的反向漏电流都会很小,不会影响正常使用. 如果长期遭受超过其所能承受的反向电压冲击时,LED 会损伤,反向漏电流会迅速变大,引起显示屏零灰度下串光的发生. 在设计中,要注意控制反向电压,建议加在 LED 上的反向电压值不超过 10V.

#### 4.1.4 The safe temperature for LEDs working 温度保护

The high temperature will make the LED's Luminous Intensity deceased radically, if LEDs worked in hot environment for a long time, they will be disabled easily. When LEDs are working in a closed array, we suggest that the LED's surface temperature should be lower than 55 and the leg's temperature should be lower than 75 .

在高温条件下,衰减会加速,寿命也会增长. 若长期处于高温环境下,极容易出现失效. 对于高密度排列使用的情况,建议在使用过程中灯面温度不超过 55°C, 灯脚温度不超过 75°C.



#### 4.1.5 Others 其它事项

Do not directly touch or handle the epoxy surface. It may damage the internal circuitry.

Handle the component along the side surfaces by using forceps or appropriate tools.

请勿直接触摸或操作环氧树脂表面，这可能会损坏内部的电路，拿取时用镊子或合适的工具夹在元件

#### 4.1.6 Declare 申明

(1) This specification is written both in English and in Chinese and the latter is formal.

此规格书以中英文方式书写，若有冲突以中文版本为准。

(2) Both the customers and Refond will agree on official specifications of supplied products before a customer's volume production. The specification is valid only after be signed. And Refond reserves the right to further modify the specification for technical reference and sample without noticing the customers.

在量产供货前，瑞丰需与客户签署一份正式的产品规格书并各自备份。规格书签核后方有效，对于客户作为技术参考以及送样时提供的规格书，瑞丰保留进一步修改而不需通知客户的权力。

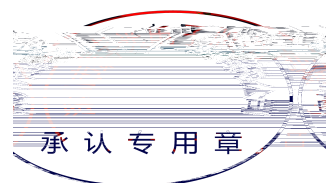

Date日期	Revisor修订者	Version版本	Verifier审核	Remarks备注
2019-03-15		E5		

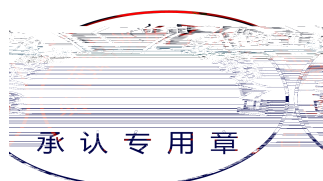

Declare 申明

This specification is written both in English and in Chinese and the latter is formal.

产品规格书以中英文方式书写，若有冲突以中文版本为准。