

SPECIFICATION

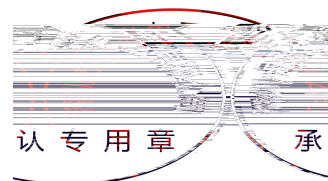

Contents

- 1. Description
 - 1.1 General Description
 - 1.2 Features
 - 1.3 Application
 - 1.4 Package Dimension
 - 1.5 Product Parameters
 - 1.6 Typical Optical Characteristics Curves
- 2. Packaging
 - 2.1 Packaging Specification
 - 2.1.1 Carrier Tape Dimension 11
 - 2.1.2 Reel Dimension 11
 - 2.1.3 Label Form Specification 12
 - 2.2 Moisture Resistant Packing
 - 2.3 Cardboard Box
 - 2.4 Reliability Test Items And Conditions
 - 2.5 Criteria For Judging Damage
- 3. SMT Reflow Soldering Instructions SMT 回流焊说明
 - 3.1 SMT Reflow Soldering Instructions SMT
- 4. Handling Precautions
 - 4.1 Handling Precautions

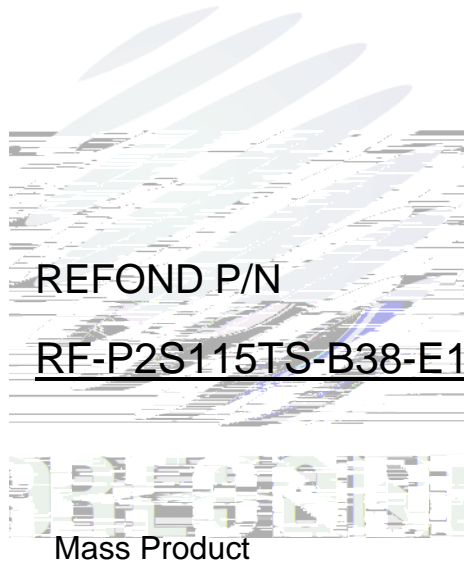
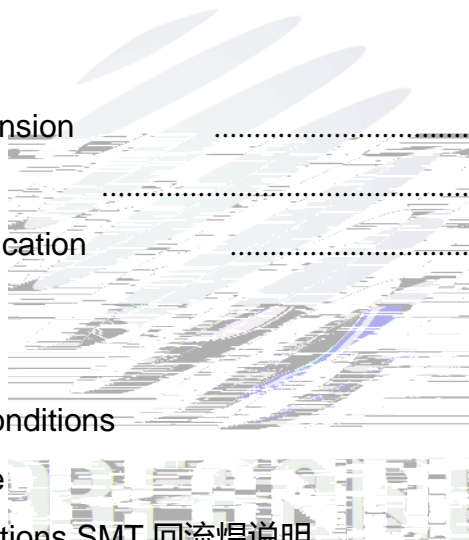

1. Description

1.1 General Description

The Colour LED which was fabricated using blue and orange chip Package Dimension :
3.2mmX1.0mmX1.48mm.

3.2mmX1.0mmX1.48mm

1.2 Features

Extremely wide viewing angle.

Suitable for all SMT assembly and solder process.

Moisture sensitivity level: Level 3.

RoHS compliant.

1.3 Application

Optical indicator.

Switch and symbol, display.

General use.

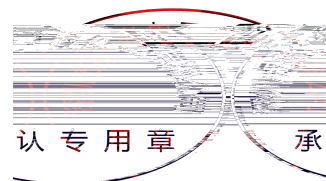
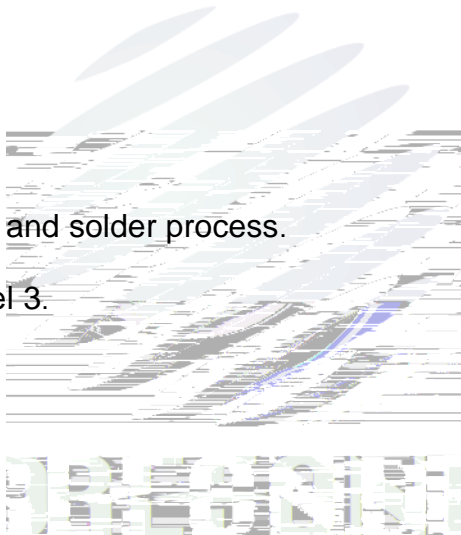

1.4 Package Dimension

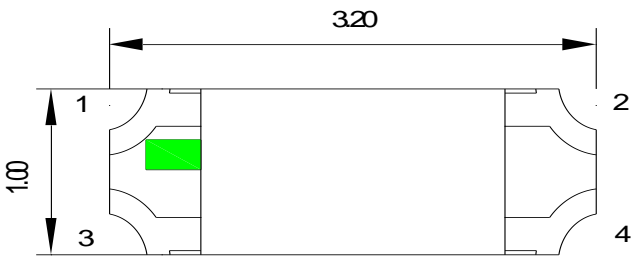

Fig.1-1 Top view

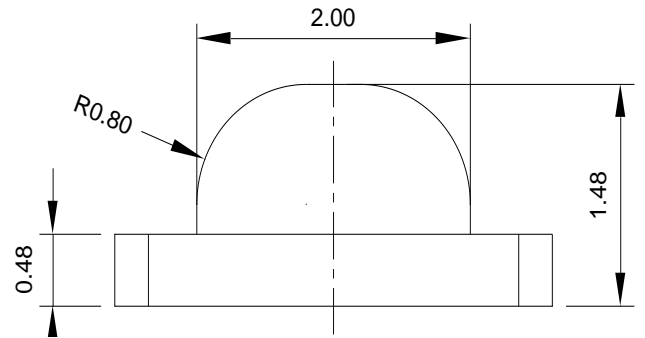

Fig.1-2 Side view

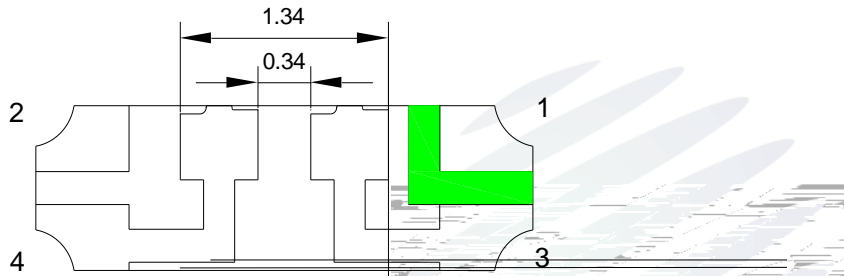

Fig.1-3 Bottom view

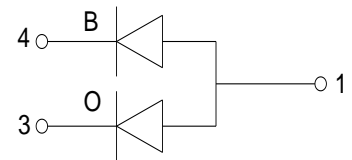

Fig.1-4 Polarity

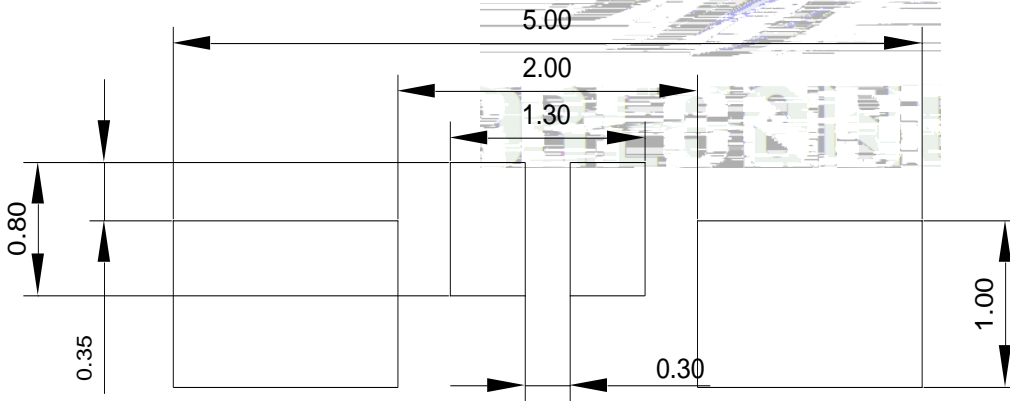
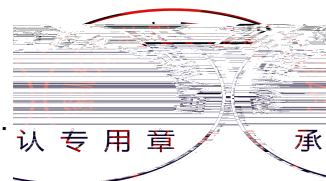

Fig.1-5 Soldering patterns

Notes

All dimensions units are millimeters.

All dimensions tolerances are $\pm 0.2\text{mm}$ unless otherwise noted.



1.5 Product Parameters

Table 1-1 Electrical / Optical Characteristics at Ts=25°C

Item	Test Condition	Symbol		Code	Value			Unit
					Min. ()	Typ.	Max.	
Spectral Half Bandwidth	I _F =20mA	Δ	O	/	--	15	--	nm
			B		--	30	--	
Forward Voltage	I _F =20mA	V _F	O	B0	1.8	--	2.0	V
				C0	2.0	--	2.2	
				D0	2.2	--	2.4	
			B	G0	2.8	--	3.0	
				H0	3.0	--	3.2	
				I0	3.2	--	3.4	
				J0	3.4	--	3.6	
Dominant wavelength	I _F =20mA	λ _d	O	D00	615	--	620	nm
				E00	620	--	625	
				F00	625	--	630	
			B	C00	460	--	465	
				D00	465	--	470	
				E00	470	--	475	
Luminous Intensity	I _F =20mA	I _v	O	G00	100	--	150	mcd
				H00	150	--	230	
				I00	230	--	350	
			B	G00	100	--	150	
				H00	150	--	230	
				I00	230	--	350	
Viewing Angle	I _F =20mA				--	140	--	deg
Reverse Current	V _R =5V	I _R			--	--	10	μA
Thermal Resistance.	I _F =20mA	R _{THJ-S}			--	--	450	/W

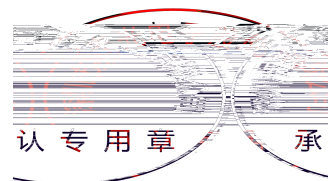

Notes : $V_R=5V$ For test conditions. $V_R=5V$

Table 1-2 Absolute Maximum Ratings at $T_s=25^\circ C$

Parameter	Symbol	Rating		Units
		O	B	
Power Dissipation	P_d	48	64	mW
Forward Current	I_F	20		mA
Peak Forward Current Of Pulse	I_{FP}	60		mA
Electrostatic Discharge (HBM)	E_{SD}	1000		V
Operating Temperature	T_{opr}	-40 ~ +85		$^\circ C$
Storage Temperature	T_{stg}	-40 ~ +85		$^\circ C$
Junction Temperature	T_j	95		$^\circ C$

Notes

- 1/10 Duty cycle, 0.1ms pulse width.
- The above forward voltage measurement allowance tolerance is $\pm 0.1V$.
- The above dominant wavelength measurement allowance tolerance is $\pm 2nm$.
- The above luminous intensity measurement allowance tolerance $\pm 10\%$.
- Care is to be taken that power dissipation does not exceed the absolute maximum rating of the product.
- All measurements were made under the standardized environment of Refond.
- When the LEDs are in operation the maximum current should be decided after measuring the package temperature, junction temperature should not exceed the maximum rate

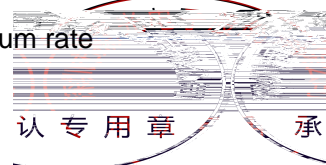

1.6 Typical Optical Characteristics Curves

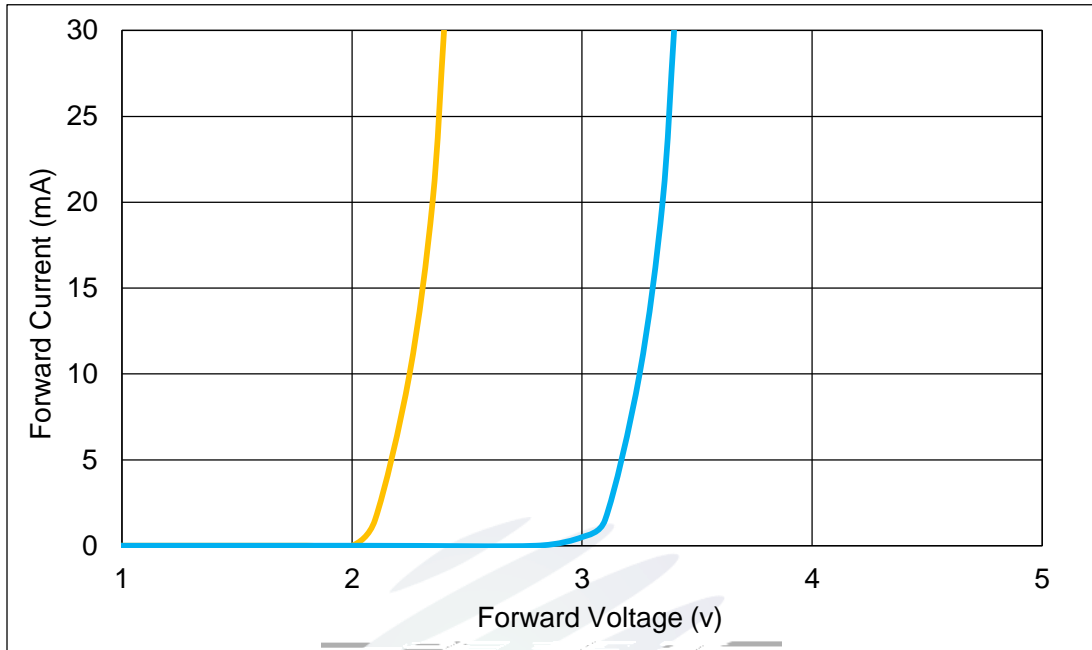

Fig.1-6 Forward Voltage Vs Forward Current

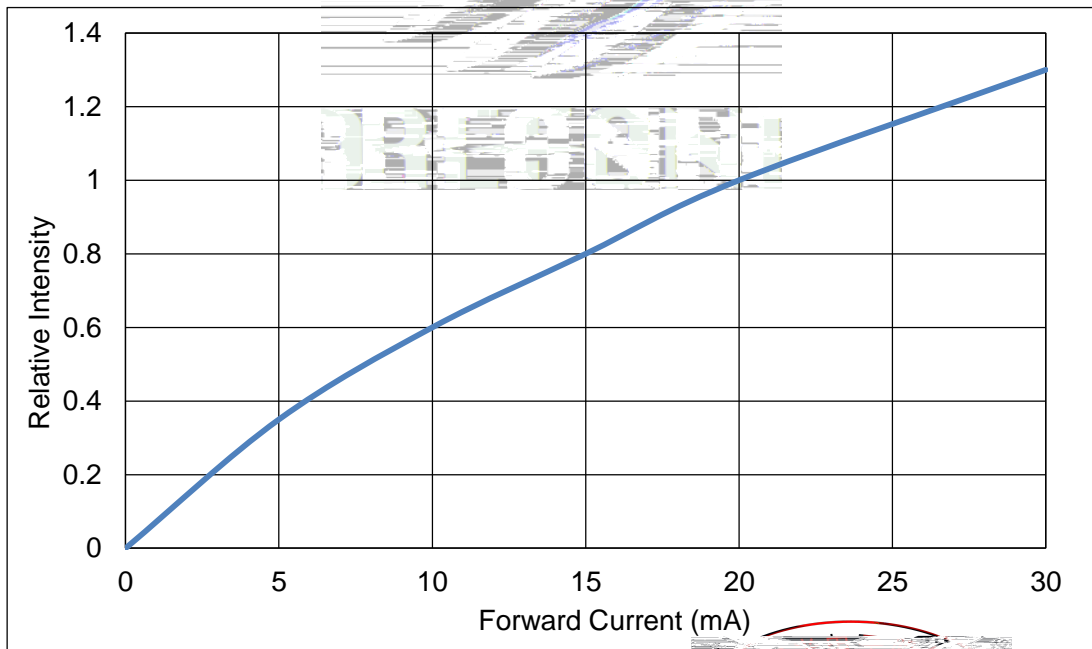
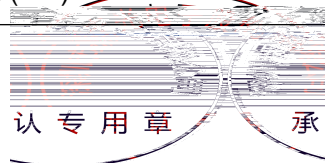

Fig.1-7 Forward Current Vs Relative Intensity





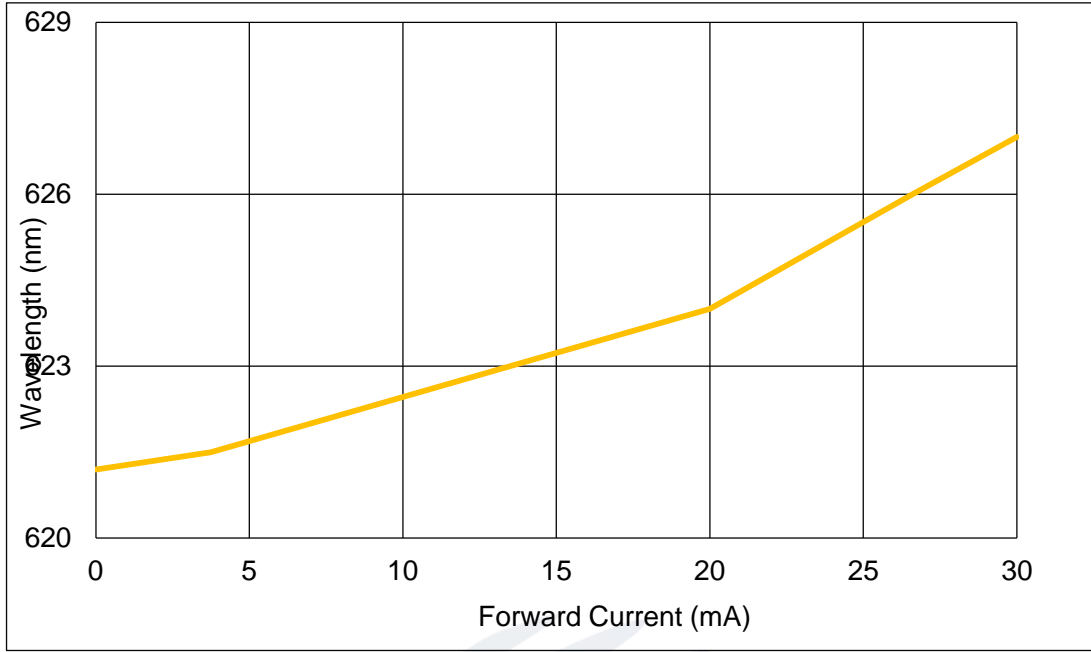

Fig.1-10 Forward Current Vs Dominate Wavelength (Ta=25°C)

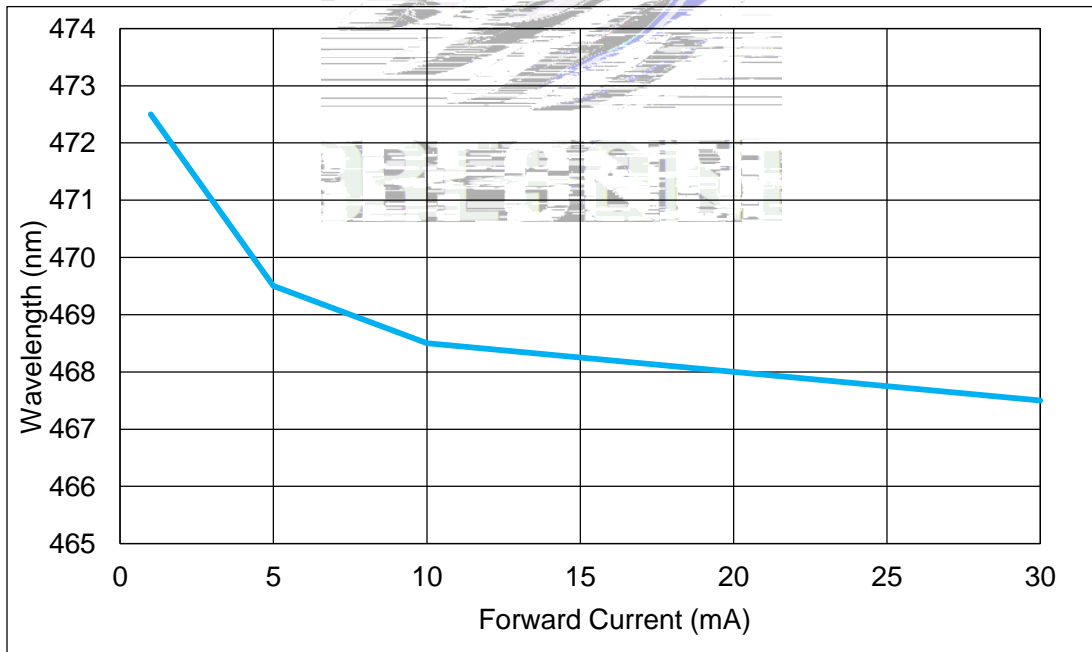
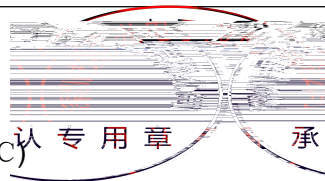

Fig.1-11 Forward Current Vs Dominate Wavelength (Ta=25°C)



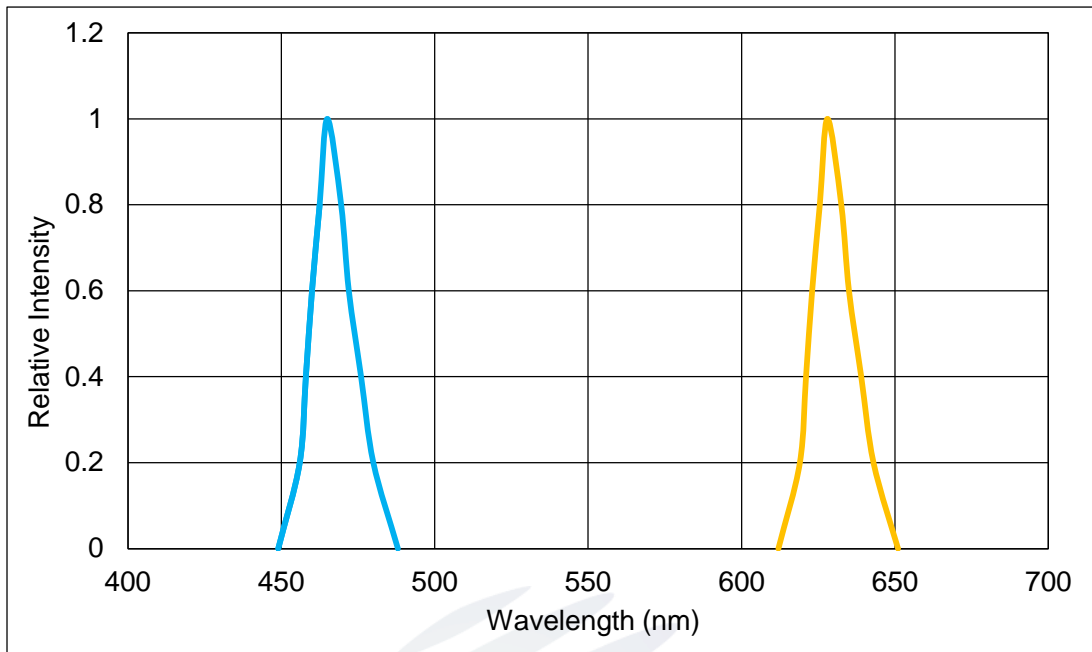

Fig.1-13 Relative Intensity Vs Wavelength (Ta=25°C)

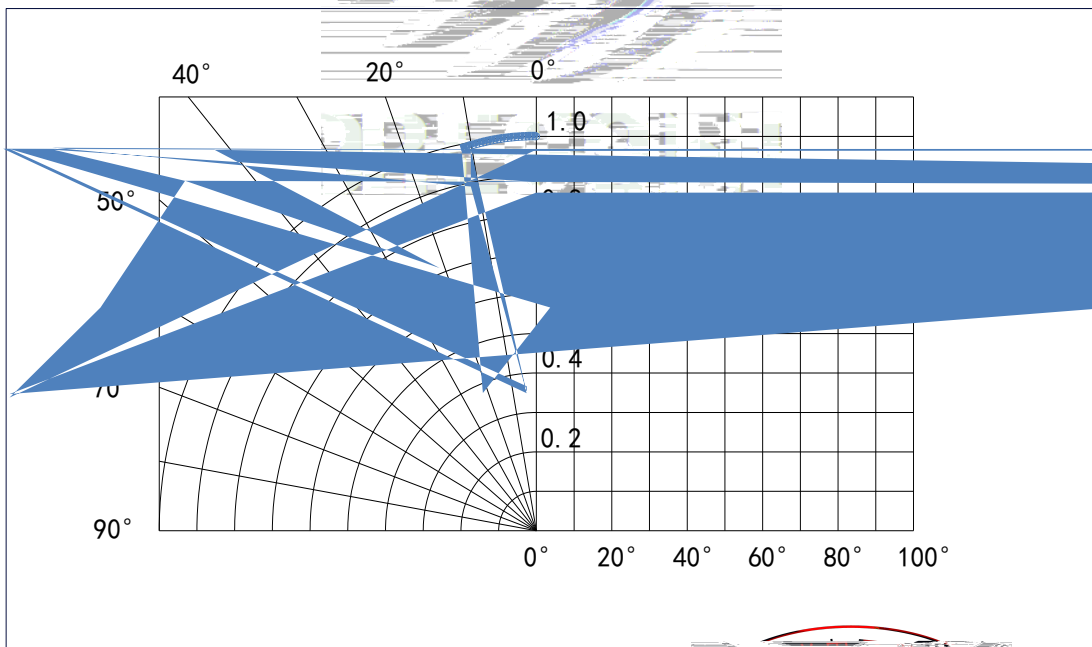
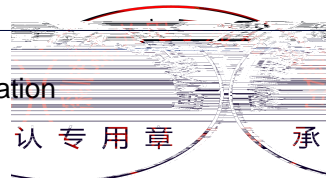

Fig.1-14 Diagram characteristics of radiation



2. Packaging

2.1 Packaging Specification

Package: 3000pcs/reel. 3000pcs

2.1.1 Carrier Tape Dimension



Fig.2-1 Carrier Tape Dimension

2.1.2 Reel Dimension

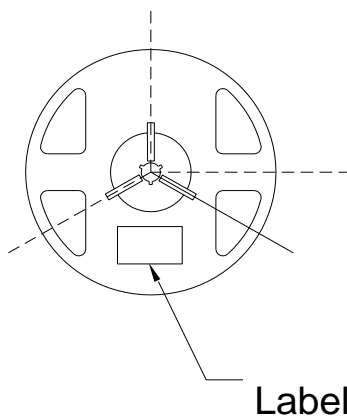

Label 标签

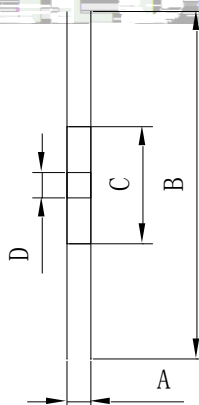

Table 2-1 Dimension

A	8.0 0.1mm
B	178 1mm
C	60 1mm
D	13.0 0.5mm

Fig.2-2 Reel Dimension

Notes

The tolerances unless mentioned $\pm 0.1\text{mm}$. Unit : mm

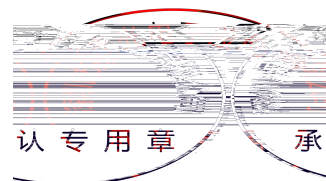

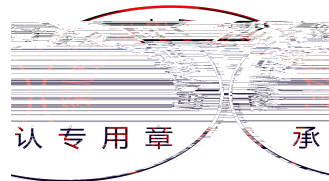

2.3 Cardboard Box

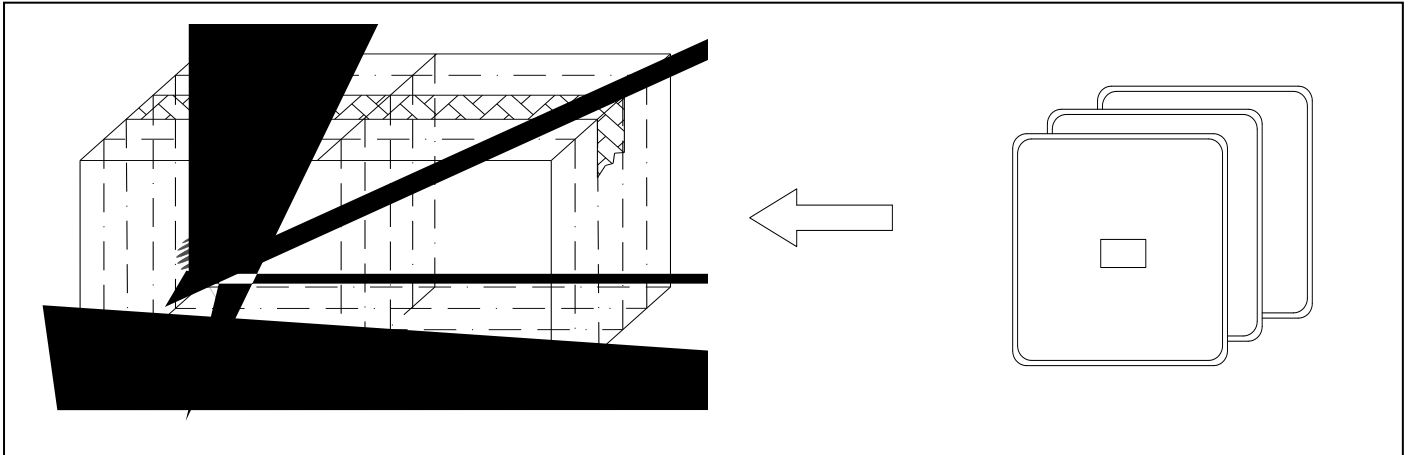

Fig.2-5 Cardboard Box

2.4 Reliability Test Items And Conditions

Table 2-3 Reliability Test Items And Conditions

Test Items	Ref.Standard	Test Condition	Time	Quantity	Ac/Re /
Reflow	JESD22-B106	Temp:260 max T=10 sec	2 times	22Pcs.	0/1
Temperature Cycle	JESD22-A104	100 30 min 5 min -40 30 min	100 cycles	22Pcs.	0/1
Thermal Shock	JESD22-A106	-40 15min 100 15min	300 cycles	22Pcs.	0/1
High Temperature Storage	JESD22-A103	Temp:100	1000 hrs.	22Pcs.	0/1
Low Temperature Storage	JESD22-A119	Temp:-40	1000 hrs.	22Pcs.	0/1
Life Test	JESD22-A108	T _a =25 I _F =20mA	1000 hrs.	22Pcs.	0/1

認專用章 承

2.5 Criteria For Judging Damage

Table 2-4 Criteria For Judging Damage

Test Items	Symbol	Test Condition	Criteria For Judgement	
			Min.	Max.
Forward Voltage	V_F	$I_F=20mA$	-	U.S.L*)x1.1
Reverse Current	I_R	$V_R= 5V$	-	U.S.L*)x2.0
Luminous Flux		$I_F=20mA$	L.S.L*)x0.7	-

Notes

1.U.S.L: Upper standard level

L.S.L: Lower standard level

2.The above reliability tests is based on the verification of a single/strip LED of Refond's existing experimental platform,the reliability experiment was taken under good heat dissipation conditions. When customers applies the LED to the series and parallel circuit,should take consideration of all the factors such as the current, voltage distribution, heat dissipation and others.

3.The technical information shown in the data sheets is limited to the typical characteristics and circuit examples of the referenced products. It does not constitute the warranting of industrial property nor the granting of any license.

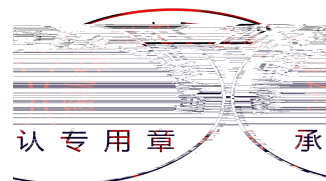

3. SMT Reflow Soldering Instructions SMT 回流焊说明

3.1 SMT Reflow Soldering Instructions SMT

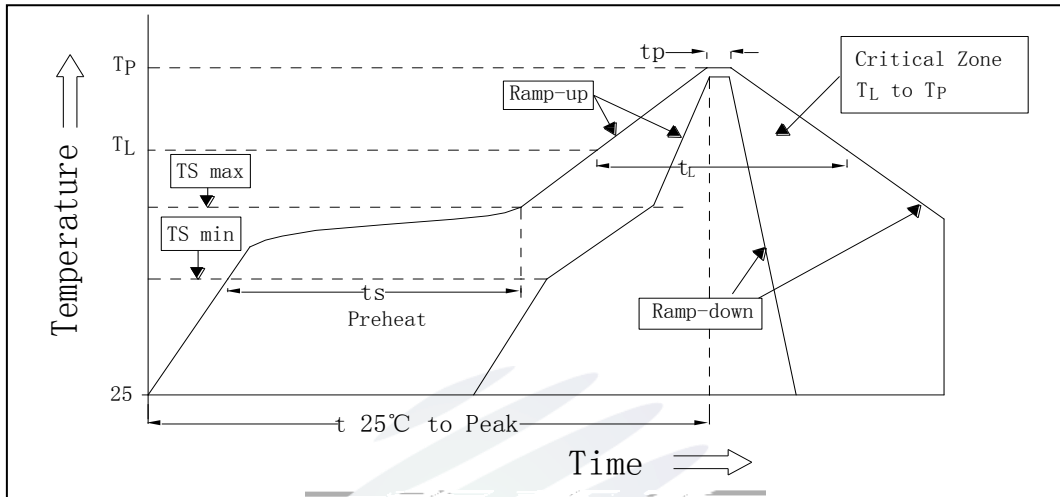

Fig.3-1 SMT Reflow Soldering Instructions SMT

Table 3-1 Parameter

Average temperature rise speed	$T_{Smax} - T_P$	3 °C/ Max 3 °C/ s
Preheating: minimum temperature	(T_{Smin})	150 °C
Preheating: Max temperature	(T_{Smax})	200 °C
Preheating: Time	$T_{Smin} - T_{Smax}$	60 - 120 60s-120s
Time limited to maintain high temperature: the temperature	(T_L)	217 °C
Time limited to maintain high temperature: The Time	(t_L)	60-150 60-150s
Peak /Classification of temperature:	(T_P)	260 °C
Time limit classification of peak temperature time	t_p	10 Max 10s
Hold time within 5 °C with the actual peak temperature (TP)	(T_P)	30 Max 30s
5 °C		
Cooling speed		6 °C/ Max 6 °C/ s
Needed time from 25 °C to T_P		Max 8 minutes

Notes

(1)Reflow soldering should not be done more than twice. If more than 24 hours between the two solderings , LED will be damaged.

(2)Whensoldering , do not put stress on the LEDs during heating.

3.1.1 Soldering Iron

(1) When do soldering by hand, keep the temperature of iron below less 300°C less than 3 seconds.

(2) Soldering by hand should be done only one time.

3.1.2 Repairing

Repairing should not be done after the LEDs have been soldered. When repairing is unavoidable,a double-head soldering iron should be used (as below figure). It should be confirmed in advance whether the characteristics of LEDs will or not be damaged by repairing.

LED

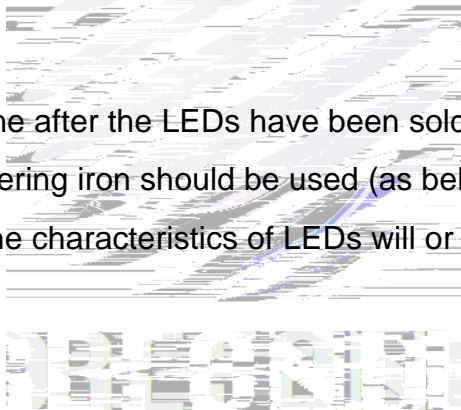

3.1.3 Cautions

(1) Components should not be mounted on warped (non coplanar) portion of PCB. After soldering, do not warp the circuit board.LED

(2) Do not apply mechanical force or excess vibration during the cooling process to normal temperature after soldering. Do not rapidly cool device after soldering.



4. Handling Precautions

4.1 Handling Precautions

(1) LED operating environment and sulfur element composition can not be over 100PPM in the LED mating usage material. This is provided for informational purposes only and is not a warranty or endorsement. LED

(2) In order to prevent external material from getting into the inside of LED, which may cause the malfunction of LED, the single content of Bromine element is required to be less than 900PPM, the single content of Chlorine element is required to be less than 900PPM, the total content of Bromine element and Chlorine element in the external materials of the application products is required to be less than 1500PPM. This is provided for informational purposes only and is not a warranty or endorsement.

(3) VOCs (Volatile organic compounds) emitted from materials used in the construction of fixtures can penetrate silicone encapsulants of LEDs and discolor when exposed to heat and photonic energy. The result can be a significant loss of light output from the fixture. Knowledge of the properties of the materials selected to be used in the construction of fixtures can help prevent these issues. Refond advises against the use of any chemicals or materials that have been found or are suspected to have an adverse effect on device performance or reliability.

To verify compatibility, Refond recommends that all chemicals and materials be tested in the specific application and environment for which they are intended to be used. Attaching LEDs, do not use adhesives that outgas organic vapor.



(4) Handle the component along the side surface by using forceps or appropriate tools; Do not directly touch or Handle the silicone lens surface, it may damage the internal circuitry.

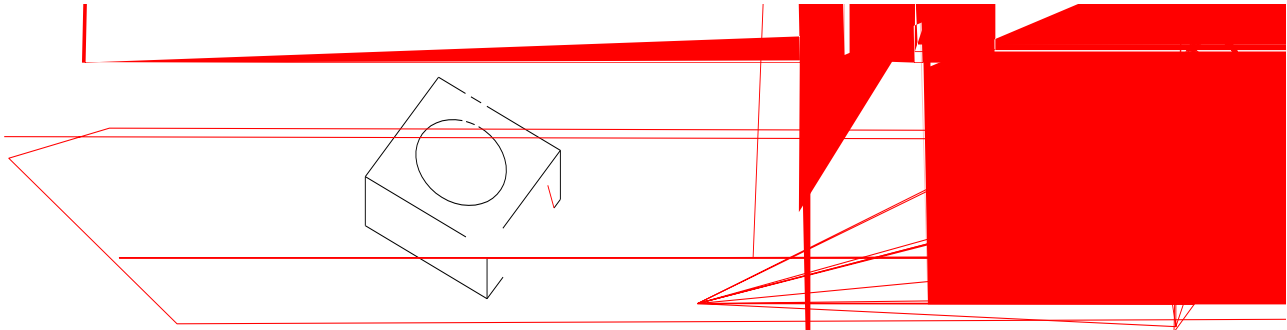

Fig 4-1

产品使用注意事项

(5) In designing a circuit, the current through each LED can not exceed the absolute maximum rating specified for each LED. In the meanwhile, resistors for protection should be applied, otherwise slight voltage shift will cause big current change, burn out may happen. The driving circuit must be designed to allow forward voltage only when it is ON or OFF. If the reverse voltage is applied to LED, migration can be generated resulting in LED damage.

(6) Thermal Design is paramount importance because heat generation may result in the Characteristics decline, such as brightness decreased, Color change and so on. Please consider the heat generation of the LEDs when making the system design. LED

(7) Compared to standard encapsulants, silicone is generally softer, and the surface is more likely to attract dust, requiring special care during processing. In cases where a minimal level of dirt and dust particles cannot be guaranteed, a suitable cleaning solution must be applied to the surface after the soldering of components. Refond suggests using isopropyl alcohol for cleaning. In case other solvents are used, it must be assured that these solvents do not dissolve the package or resin. Ultrasonic cleaning is not recommended. Ultrasonic cleaning may cause damage to the

LED.

Table 4-1 Storage

Conditions		Temperature	Humidity	Time
Storage	Before Opening Aluminum Bag	30	75%	Within 1 Year From Date
	After Opening Aluminum Bag	30	60%	24hours 24
Baking		60 ± 5	-	24hours 24

(8) If the moisture absorbent material (silica gel) has faded away or the LEDs have exceeded the storage time, baking treatment should be performed after unpacking and based on the following condition (65±5) °C for above 24 hours.

If the package is flatulence or damaged, please notify the sales staff to assist.

(9) Similar to most Solid state devices; LEDs are sensitive to Electro-Static Discharge (ESD) and Electrical Over Stress (EOS).

(10) Other points for attention, please refer to our relevant information.

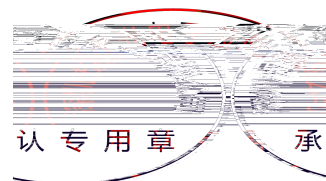



Declare

This specification is written both in English and in Chinese and the latter is formal.

